

Industrial power supply AC-DC or DC-DC up to 1500 Watts output: 110Vdc, 115Vdc, 125Vdc, 127Vdc ... 250Vdc AL175



• DIN RAIL or surface mounting

1500 Watts total, 1 to 6 outputs.
Output voltage: 5 Vdc.....480 Vdc.
(application : 110 Vdc and 127 Vdc).

• AC or DC Input: Switching-mode power supply.

85 265 Vac (50 Hz, 60 Hz, 400 Hz).
24Vdc, 48Vdc, 125Vdc...370Vdc...1200Vdc, 900Vdc..2200Vdc.

• Fully protected : Short circuit, overload, thermal.

- **AL175L** natural convection, 500 Watts max.
- **AL175** fan cooling, 1000 Watts max.
- **AL175HD** fan cooling, 1500 Watts max.
- **AL175R** redundant version.
- **AL175HV** High voltage input version, 900 to 2200Vac or dc

• Option: Ethernet link for remote monitoring.

Internal ORing diode for parallel coupling.
Watchdog relay for "output OK".
Analog output 0...10 V ; 4...20 mA copy of output current.

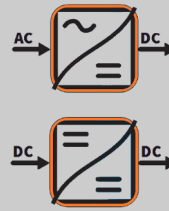

Description:

- Switching power supply allowing high power density without excessive overheating due to the high efficiency of electronic.
- 1 to 6 isolated outputs allowing serial or parallel coupling, in order to have exotic or symmetric output voltages, or to increase the available output current.

Features:

- DIN rail or surface mounting,
- Pluggable screw terminal blocks (6 mm² max) or fixed terminal block up to 16 mm² depending on output current.
- Glass fiber reinforced polycarbonate case.
- UL 94-V0 flammability class.
- IP20 protection class.
- High resistance to vibration and shock.
- Low sensitivity to humidity and dust.
- Protected against overload.
- Protected against continuous short circuit.
- Thermal protection (output power limitation).
- Natural convection for AL175L or forced air cooling for AL175.
- Embedded EMC filter in accordance with EN55022 class A.

Specific customization on request:

Single output voltage: 24, 30, 48, 72, 110, 125, 127 V,....
or symmetric: +/-12 , +/-15, +/-24 , +/-48, +/-125 V,....

Implementation and installation recommendations:

- Primary fuse protection recommended (delayed 15 A).
- Be careful with positioning to ensure proper ventilation.
- Keeping a minimum of 25 mm space between modules.

AL175-CMTCP



Version and order code:

[Request a quote](#)

AL175(HD): 1 output, fan cooling

Option : - **D** : Internal ORing diode for parallel coupling

- **Wd** : Output watchdog relay monitoring output voltage

- **S2,S3,S4,S5,S6** : 2 to 6 isolated outputs.

- **/S** : analog output. 4-20 mA; 0-10 V. Image of output current

- **HT** : High temperature version

Communication: (monitoring of output voltage and current)

- **SNMP** : Ethernet link with SNMP protocol

- **CMTCP** : Ethernet link with Modbus-TCP protocol

AL175L: Fanless, natural convection cooling version.

AL175E: Narrow enclosure version (vertical mounting).

AL175HV: 900 to 2200 V high voltage input version.

AL175R-WD: 2 internal redundant power supplies (parallel coupling) with 2 relays indicating proper operation of each power supply.

Special versions

AL175FIL: Filtered rectified output (applications : motor / contactor)

AL175C: Lead battery charger version.

Power supply

Standard input voltage 85...265 Vac / 110...370 Vdc
 On request up to 1500 Vac or 2500 Vdc
 Input frequency 47...440 Hz
 Typical efficiency >90 %
 Power factor >0.94 @ 230 Vac full load
 Inrush current 15 A typical

Output

Output trim accuracy +/-2 % max. (+/- 1% on request)
 Output regulation +/-2 % max. (full load)
 Line regulation (input variation) : +/- 0.5 %
 Ripple < 1 % (limited to 20MHz)
 Thermal stability +/-0.02 % /°C typical
 Noise and residual ripple: <100mVpp (20Mhz bandwidth)
 Continuous short circuit protection, automatic restart.
 Overload protection 110 to 140 % of nominal current.
 Switching frequency 60 kHz typ.
 Output hold time 50 ms typical.

Watchdog relay

Free potential changeover contact
 Dielectric strength (isolation) >2500 Vac
 impulse withstand voltage (1.2 / 50µ) 6000 V
 AC switching capacity: 250 Vac (400Vac) 6 Aac 2000 VA
 DC switching capacity: 300 Vdc 0.3 Adc 90 W
 DC switching capacity: 30 Vdc 5 Adc 150 W

Output power function of input voltage

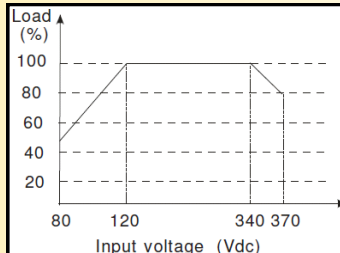
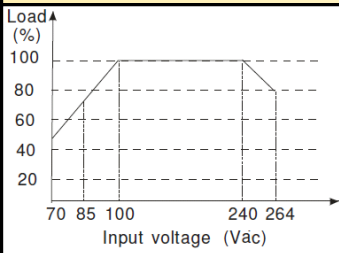

ENVIRONMENT

AL175 operating temperature -25 °C to 60 °C
 AL175-HT operating temperature -25 °C to 75 °C
 AL175L operating temperature -25 °C to 50 °C
 Storage temperature -30 °C to 85 °C
 Thermal protection 100 °C internal
 Humidity 85 % (not condensed)
 Insulation resistance 100 MΩ min.
 Dielectric strength 2500 Vac
 Weight 2000 g
 MTBF (+25 °C) 350 000 hrs (excluding fan)
 Lifetime > 100 000 hrs (> 50 000 hrs with fan)

Output power function of ambient temperature

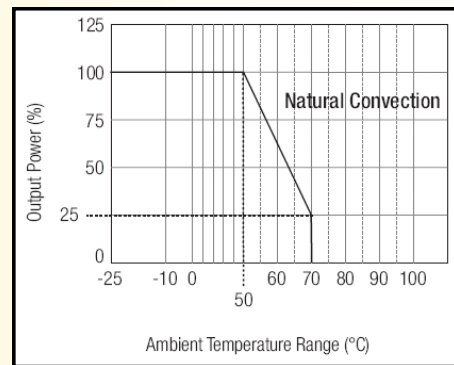

Electromagnetic compatibility 2014/30/UE / Low Voltage Directive 2014/35/UE

Immunity standard for industrial environments EN 61000-6-2		Emission standard for industrial environments EN 61000-6-4
EN 61000-4-2 ESD	EN 61000-4-8 AC MF	EN 55011 group 1 class A
EN 61000-4-3 RF	EN 61000-4-9 pulse MF	
EN 61000-4-4 EFT	EN 61000-4-11 AC dips	
EN 61000-4-5 CWG	EN 61000-4-12 ring wave	
EN 61000-4-6 RF	EN 61000-4-29 DC dips	



WIRING AND OUTLINE DIMENSIONS:

version: AL175-WD 1 output with watchdog relay

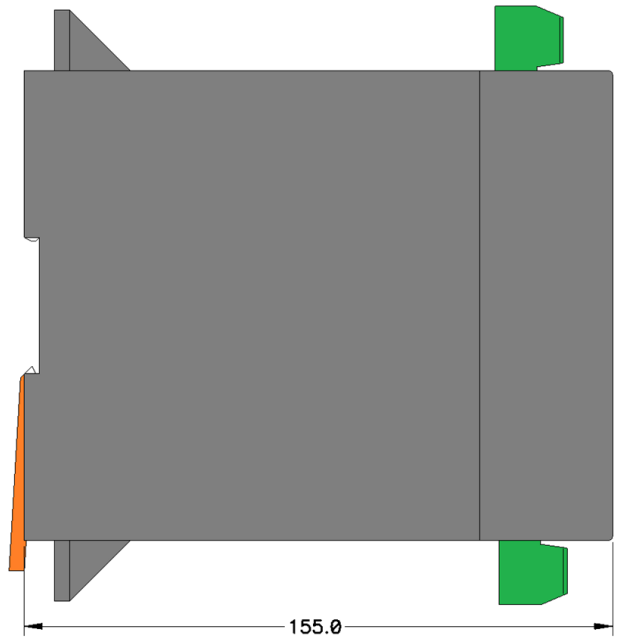
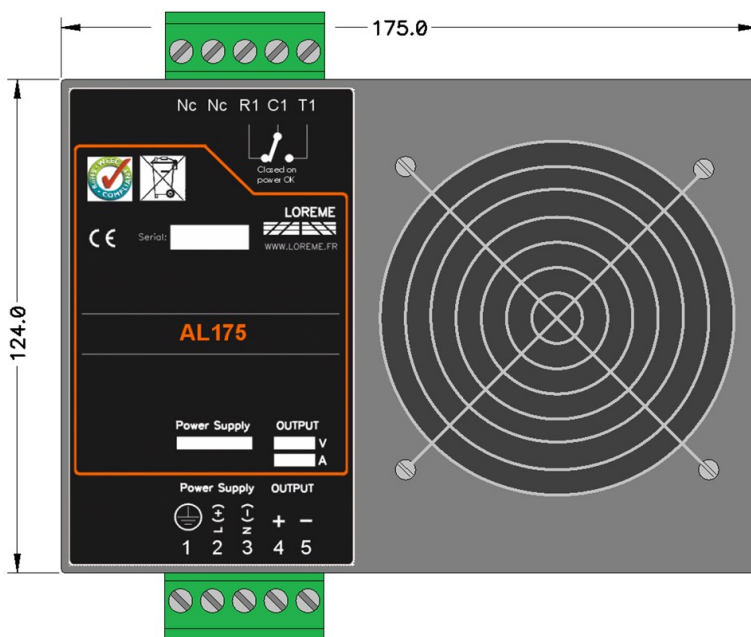

AL175-WD

Simple power supply,
without redundancy.

with watchdog relay

can be associated with
external redundancy
modules :

http://www.loreme.fr/fichtech/MPA2_eng.pdf

http://www.loreme.fr/fichtech/MPA3_eng.pdf

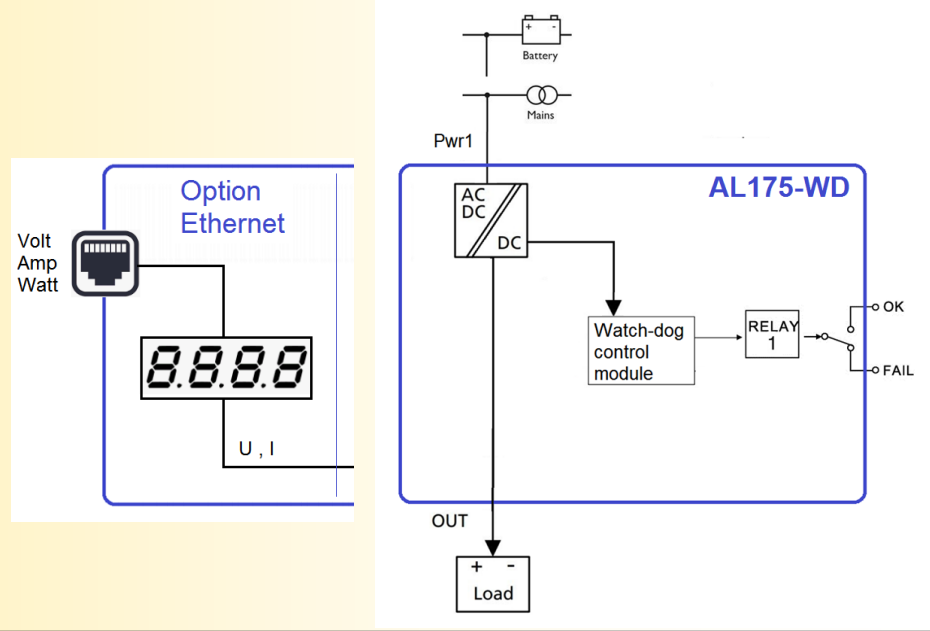

AL175D-WD

Power supply with internal
diode for parallel coupling,
with watchdog relay

To ensure the redundancy
function (operation with
single power supply) :
The output power match
the power of one supply.

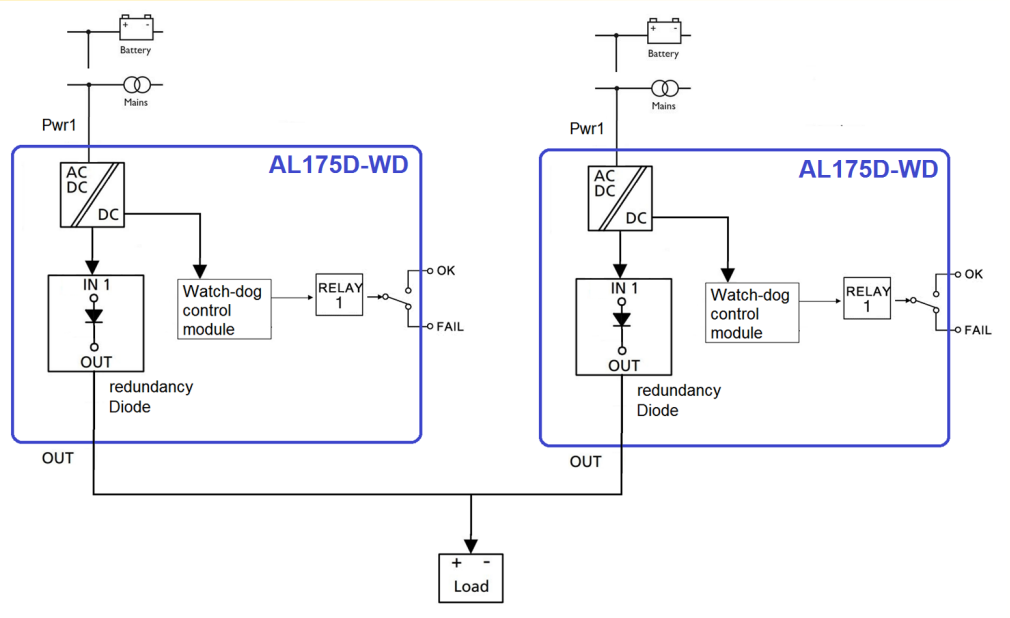

AL175R-WD

Double power supply with
redundancy module
and 2 watchdog relays

To ensure the redundancy
function (operation with
single power supply)
The output power match
the power of one of twos
internal supplies

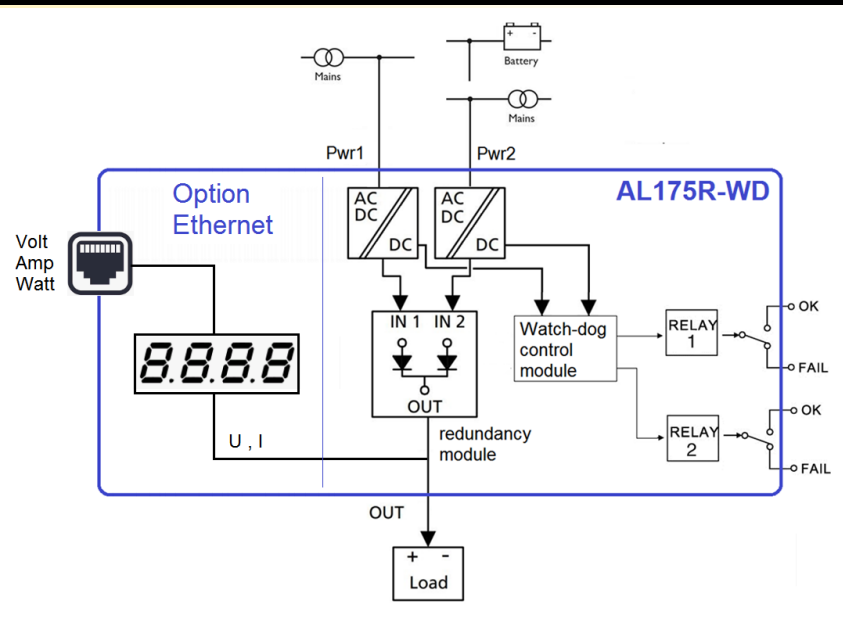

AL175-S3 3 isolated outputs

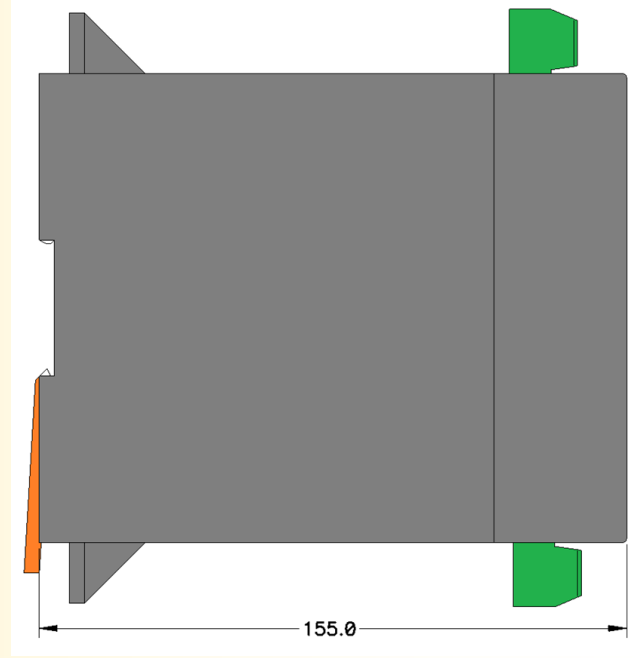
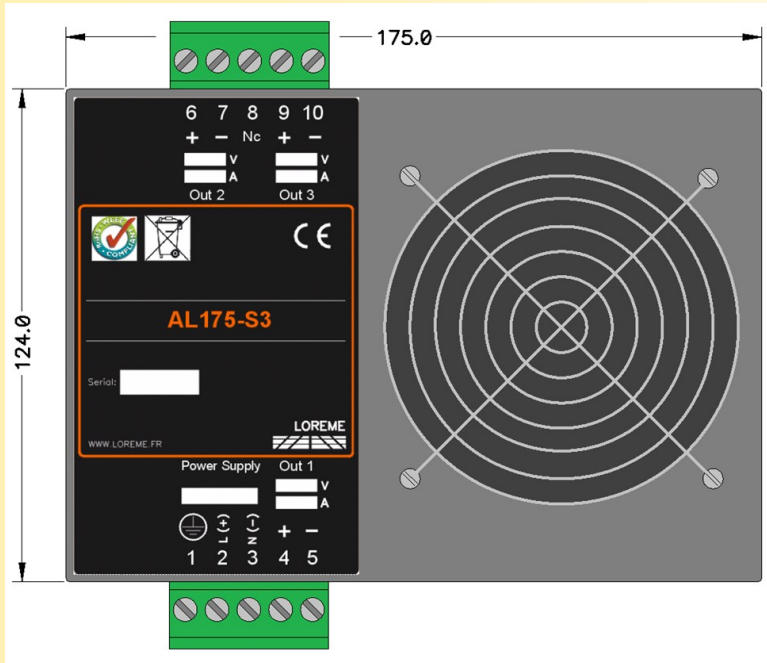

AL175-S3 3 not isolated outputs with common ground

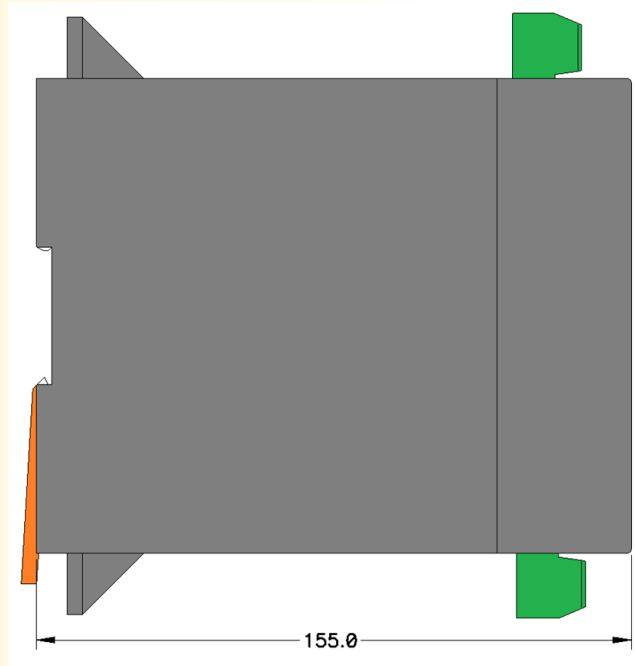
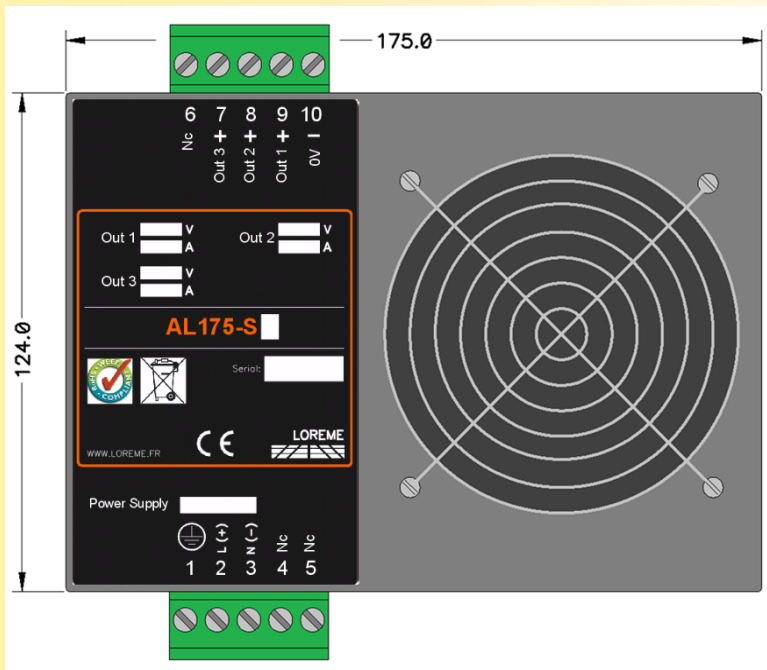

AL175R-WD 2 inputs, 1 redundant output and 2 watchdog relays

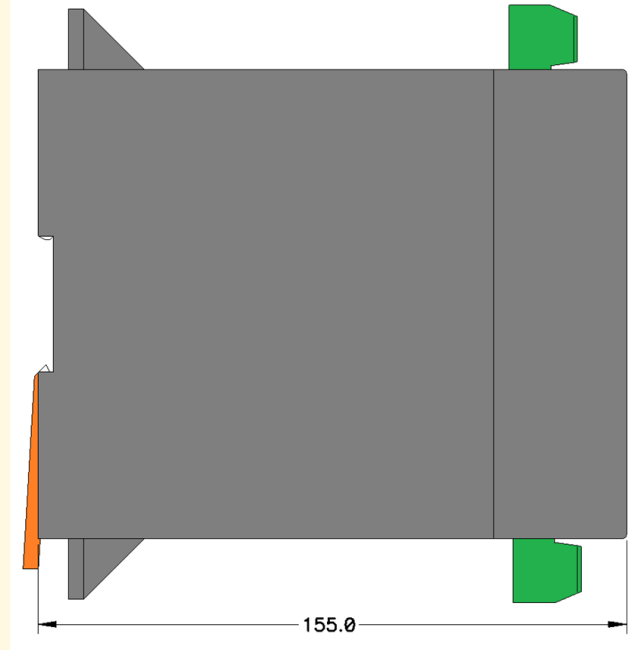
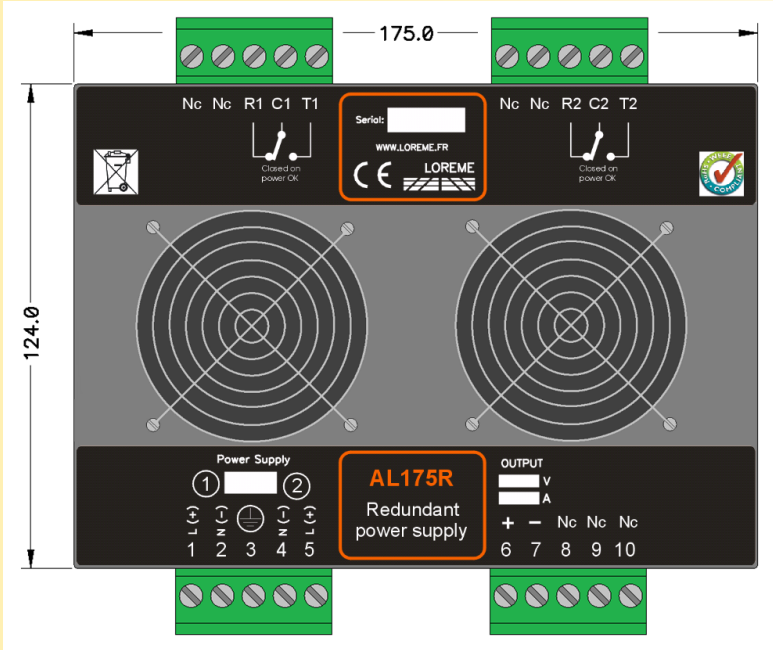

AL175L-WD Natural convection, 1 output with watchdog relay

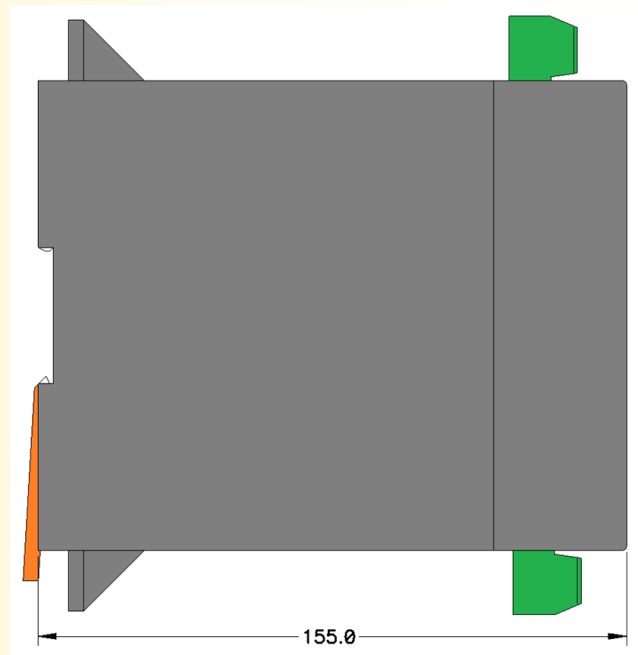

AL175HV High voltage input

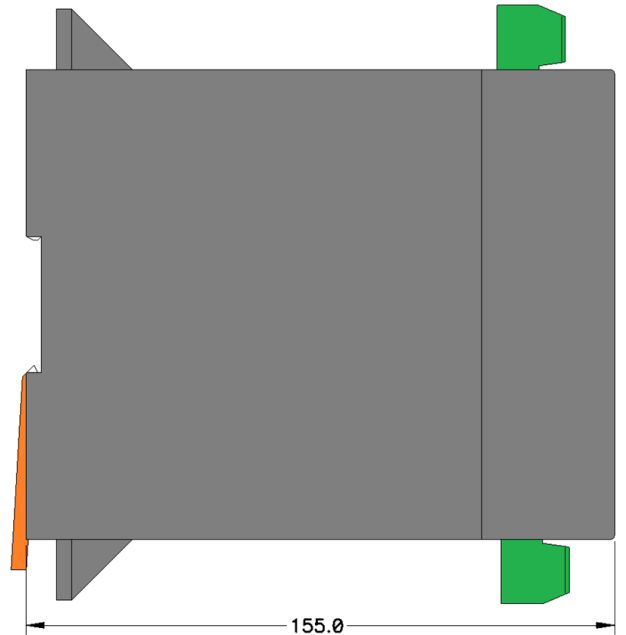

AL175CMTCP With Modbus TCP communication

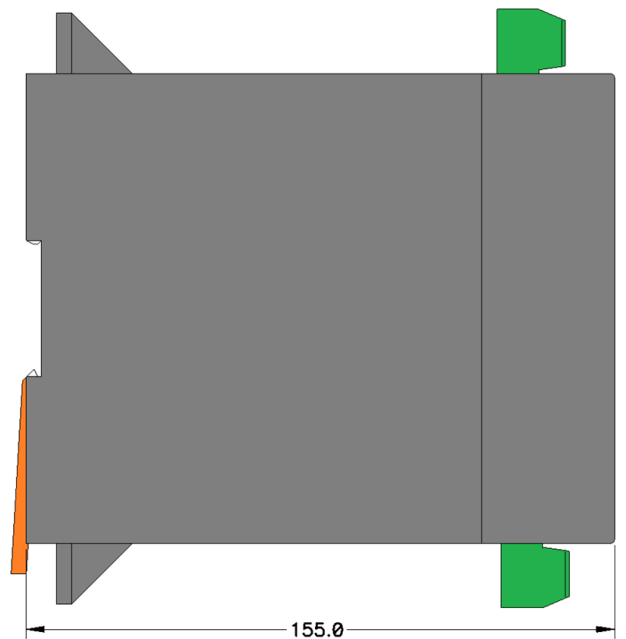
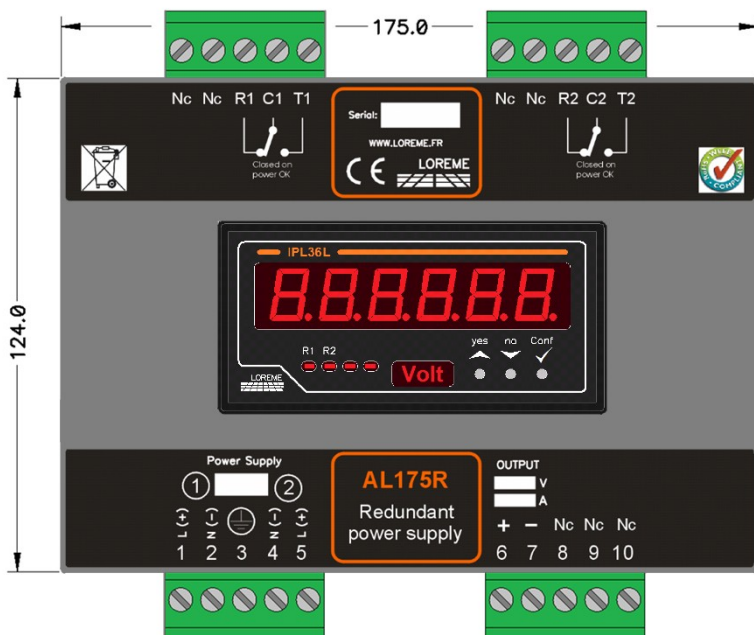

AL175E narrow version (vertical mounting)

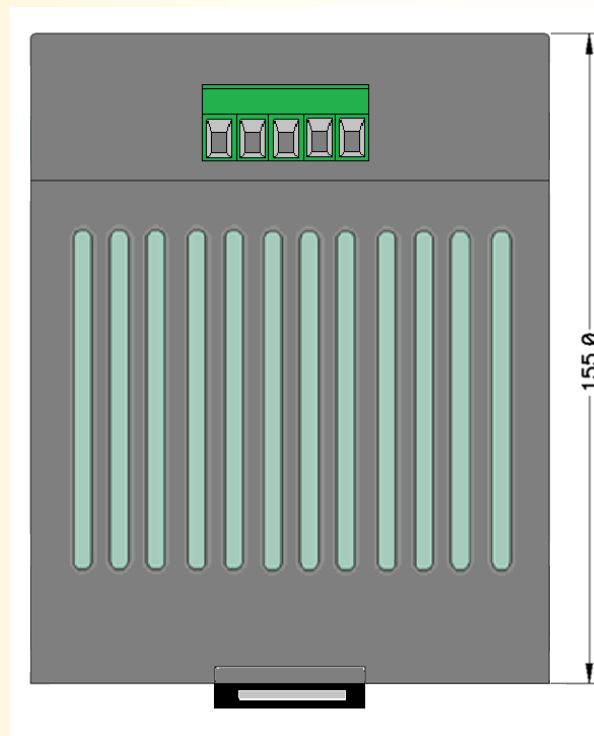
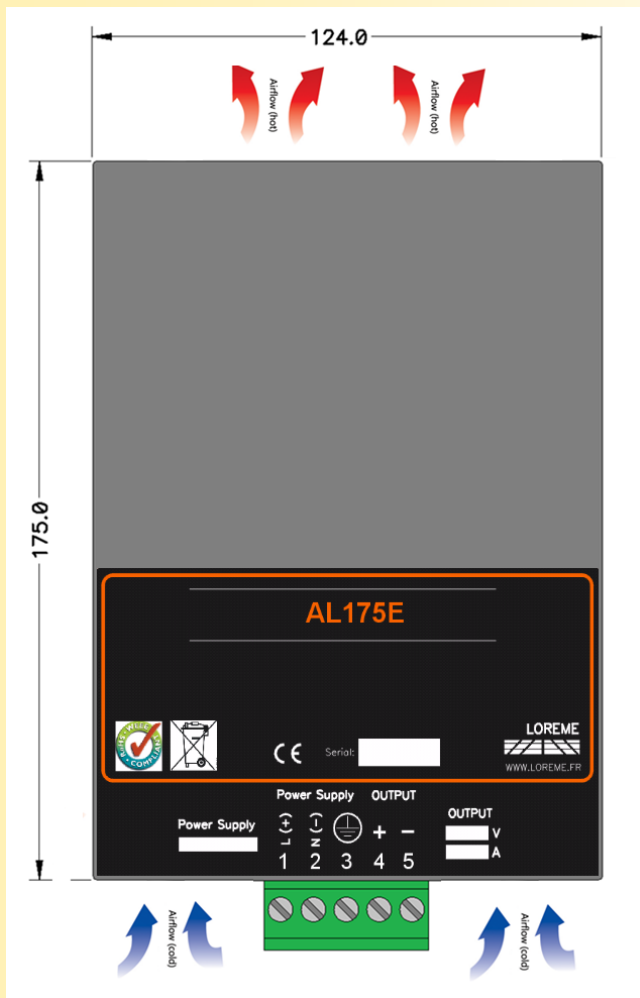

AL175HD High density version

